

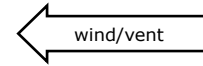

EIAC, Deva, Romania 2021		Form B
Pilot ID	CIVA Intermediate Unknown1	Flight #

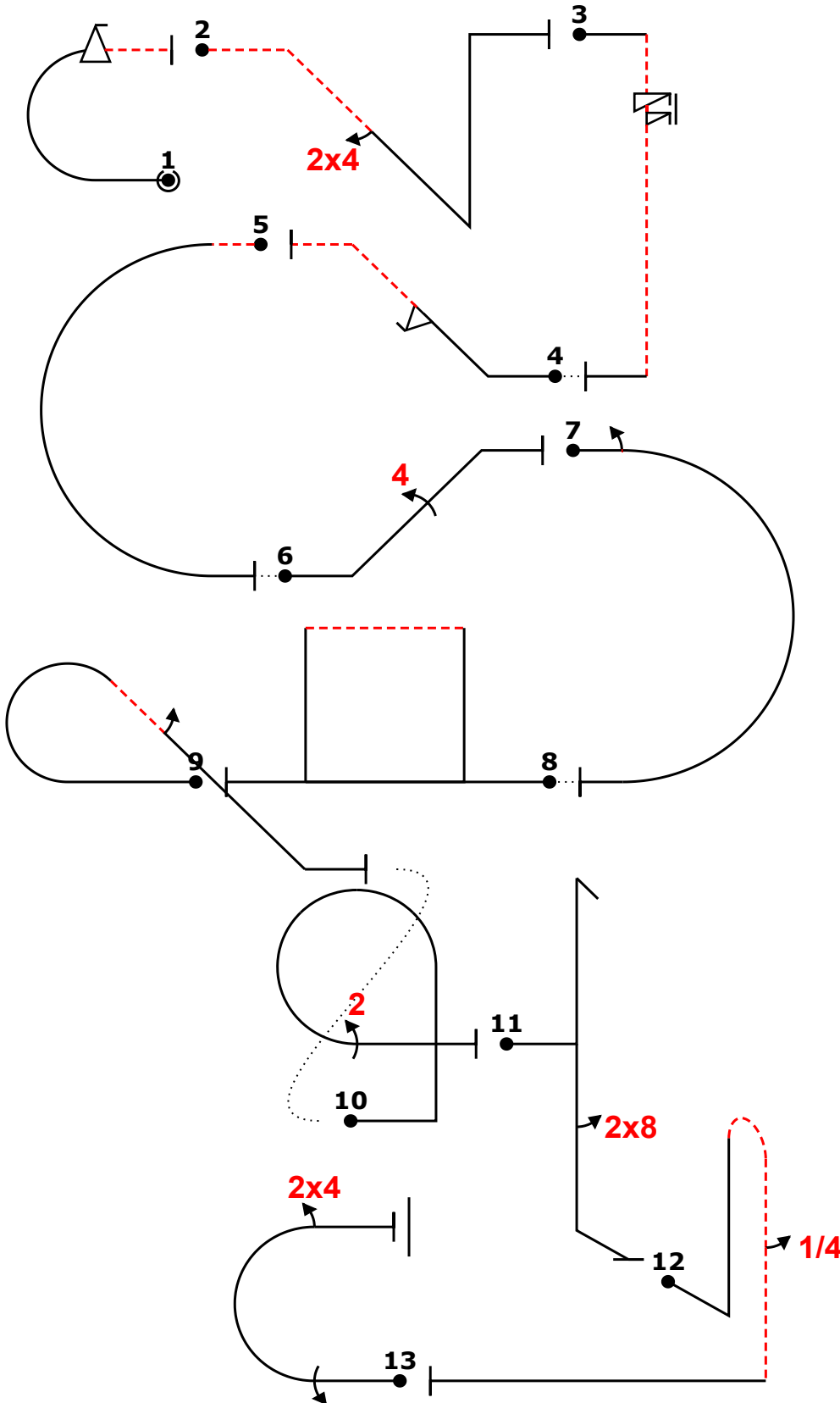

**A**



Power			
Fig	Aresti	K	
1	7.2.1.1	6	17
A	9.9.3.4	11	
2	1.2.4.4	13	18
F	9.4.4.2	5	
3	1.1.6.3	10	13
I	9.11.1.6	3	
4	1.1.3.1	7	20
C	9.9.2.2	13	
5	7.2.1.4	6	8
Add.			
6	1.1.2.1	7	20
B	9.4.2.4	13	
7	7.2.3.3	6	8
Add.	9.1.3.2	4	
8	7.4.3.1	14	14
H			
9	8.5.6.1	10	8
Add.	9.1.4.2	4	
10	8.6.1.1	11	20
E	9.2.3.4	9	
11	5.2.1.1	17	20
J	9.8.5.1	3	
12	8.4.3.1	15	17
G	9.1.5.1	2	
13	7.2.2.1	6	19
D	9.1.3.4	8	
	9.4.3.2	5	
<b>Total K = 202</b>			

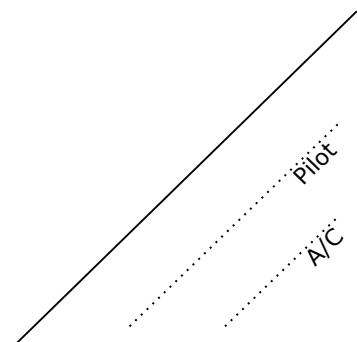



EIAC, Deva, Romania 2021		Form B
Pilot ID	CIVA Intermediate Unknown1	
		Flight #

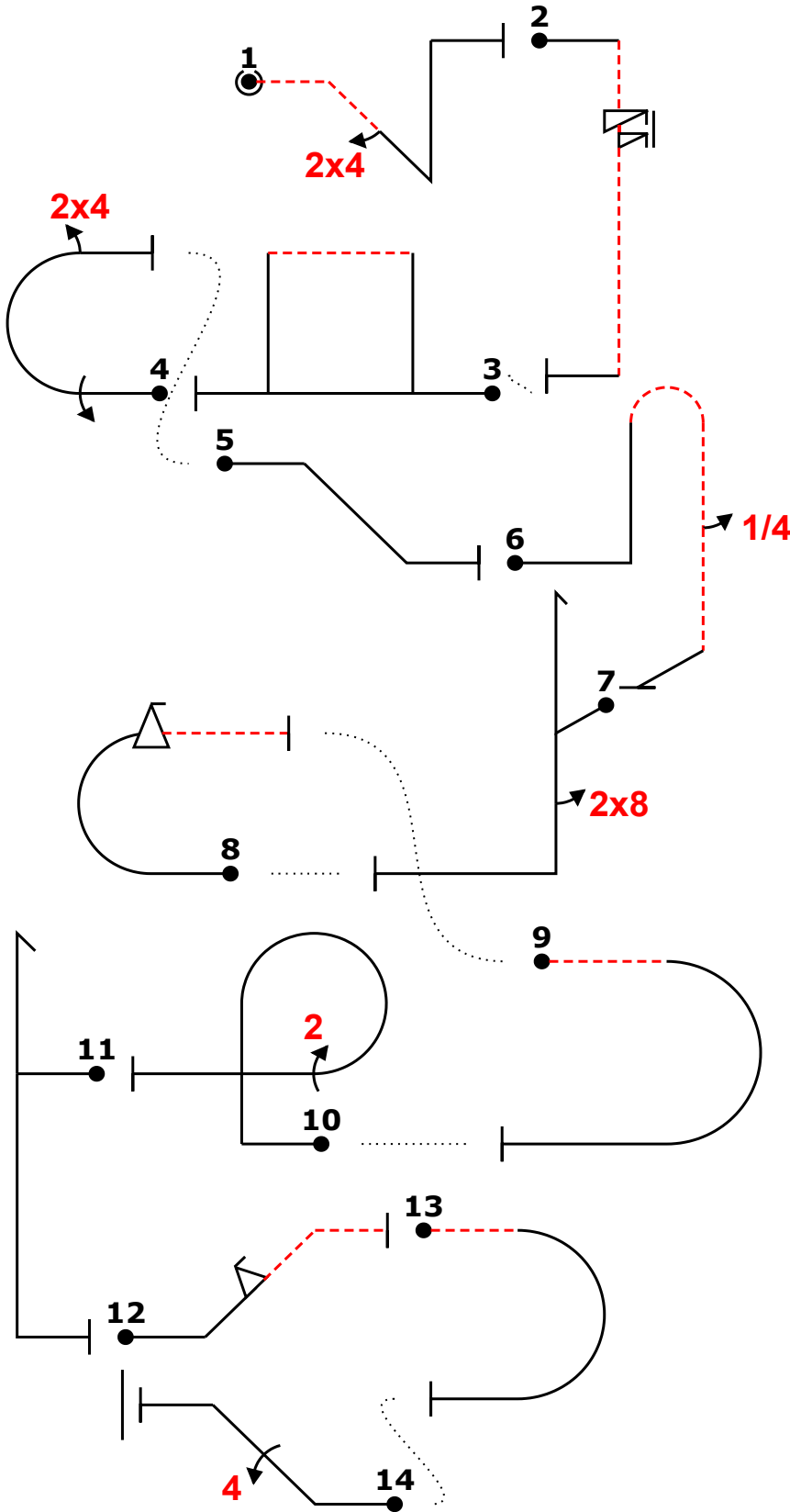
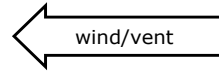

Power			
Fig	Aresti	K	
1	1.2.4.4 F 9.4.4.2	13 5	18
2	1.1.6.3 I 9.11.1.6	10 3	13
3	7.4.3.1 H	14	14
4	7.2.2.1 D 9.1.3.4 9.4.3.2	6 8 5	19
5	1.1.2.3 Add.	7	6
6	8.4.3.1 G 9.1.5.1	15 2	17
7	5.2.1.1 J 9.8.5.1	17 3	20
8	7.2.1.1 A 9.9.3.4	6 11	17
9	7.2.1.4 Add.	6	6
10	8.6.1.1 E 9.2.3.4	11 9	20
11	5.2.1.1 Add.	17	6
12	1.1.3.1 C 9.9.2.2	7 13	20
13	7.2.1.4 Add.	6	6
14	1.1.2.1 B 9.4.2.4	7 13	20
<b>Total K = 202</b>			

**B** ... .. текст

\_\_\_\_\_/ Pilot  
 ...../ A/C  
 ...../ A/C



EIAC, Deva, Romania 2021		Form B
Pilot ID	CIVA Intermediate Unknown1	Flight #

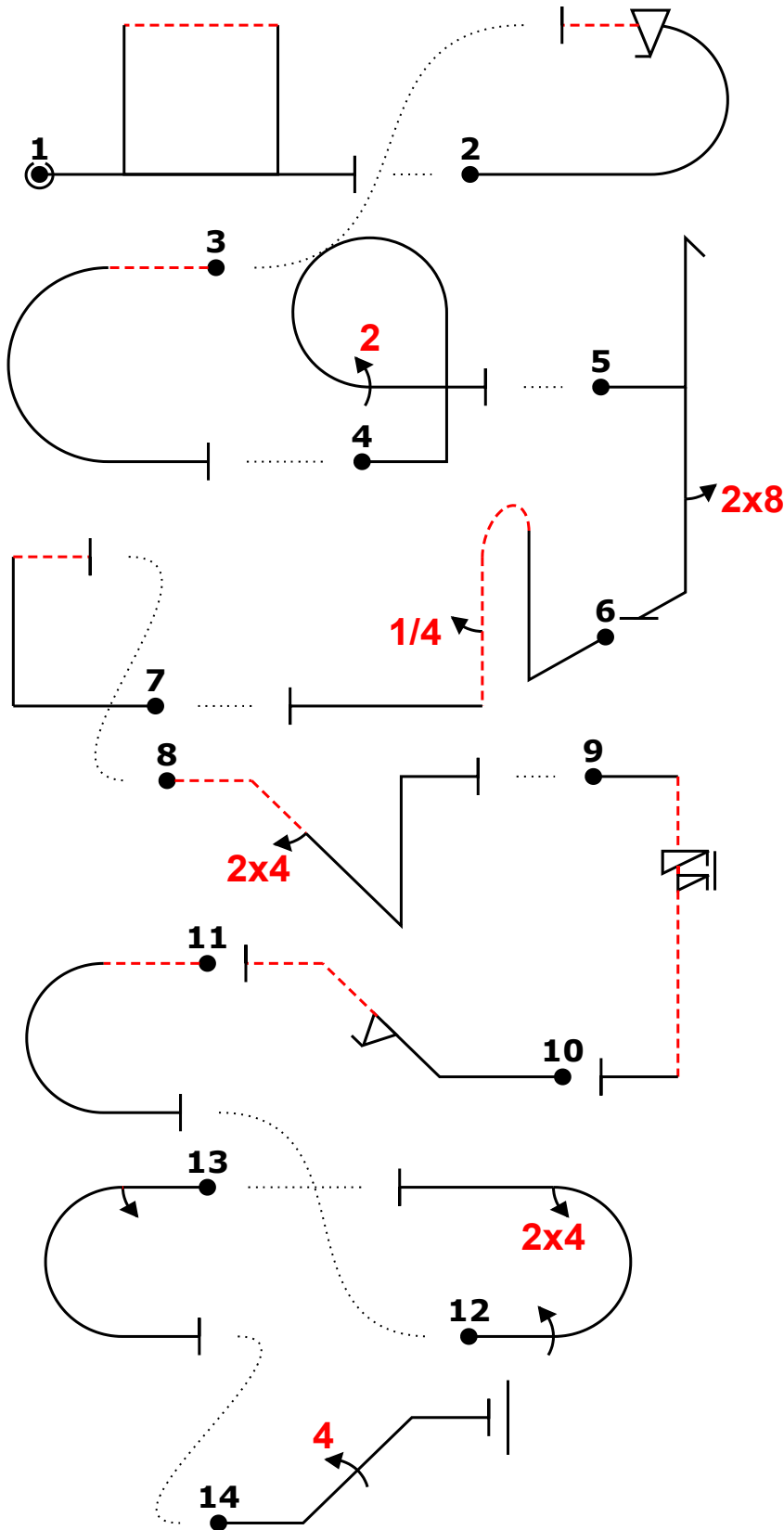
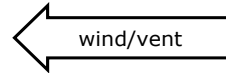

Power			
Fig	Aresti	K	
1 H	7.4.3.1	14	14
2 A	7.2.1.1 9.9.3.4	6 11	17
3 Add.	7.2.1.4	6	6
4 E	8.6.1.1 9.2.3.4	11 9	20
5 J	5.2.1.1 9.8.5.1	17 3	20
6 G	8.4.3.1 9.1.5.1	15 2	17
7 Add.	1.1.7.1	9	6
8 F	1.2.4.4 9.4.4.2	13 5	18
9 I	1.1.6.3 9.11.1.6	10 3	13
10 C	1.1.3.1 9.9.2.2	7 13	20
11 Add.	7.2.1.4	6	6
12 D	7.2.2.1 9.1.3.4 9.4.3.2	6 8 5	19
13 Add.	7.2.3.3 9.1.3.2	6 4	6
14 B	1.1.2.1 9.4.2.4	7 13	20
<b>Total K = 202</b>			

C

\_\_\_\_\_/ Pilot  
 ..... A/C



EIAC, Deva, Romania 2021		Form B
Pilot ID	CIVA Intermediate Unknown1	
		Flight #

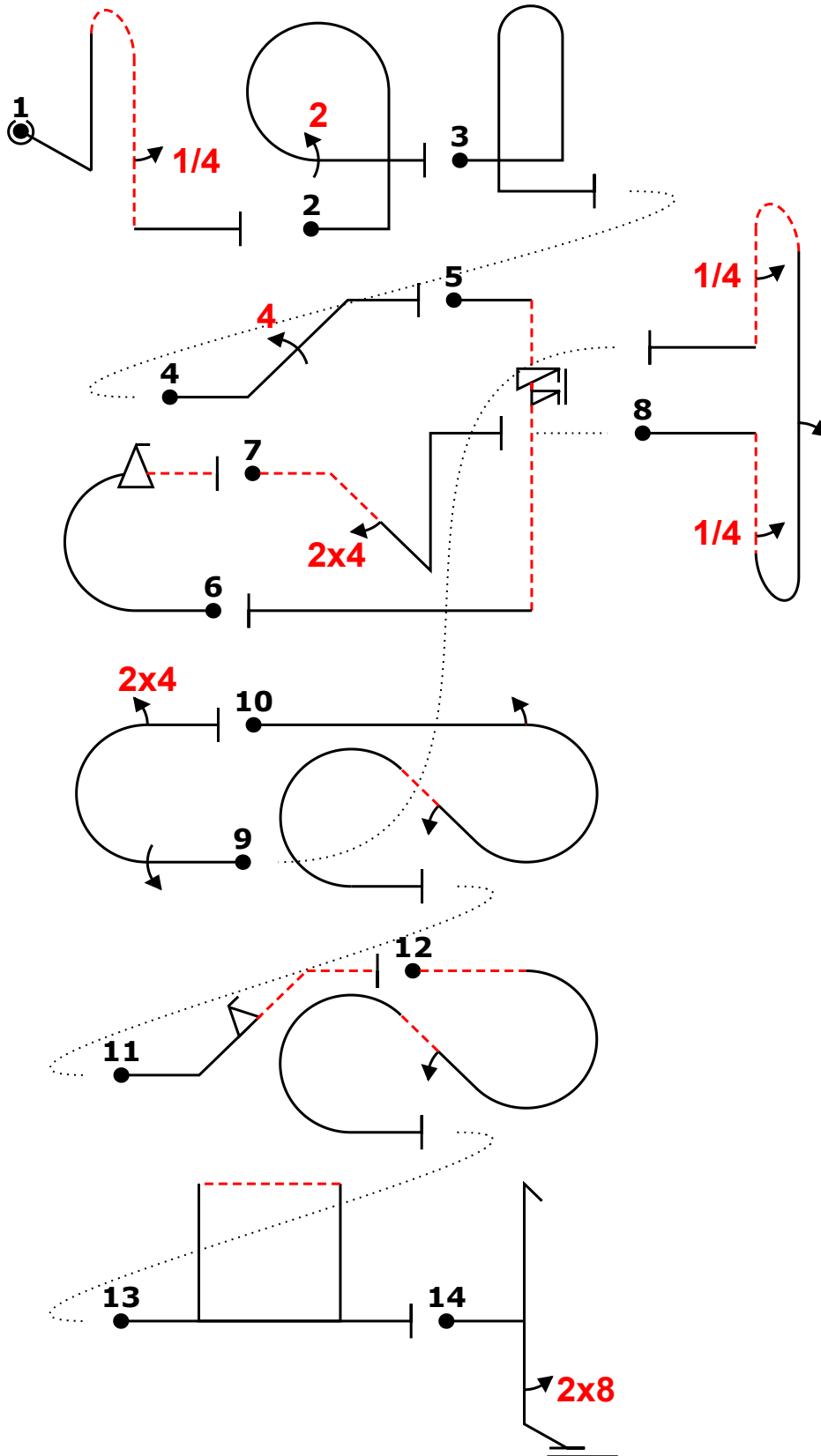
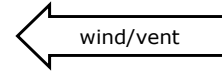

Power			
Fig	Aresti	K	
1	8.4.3.1	15	17
G	9.1.5.1	2	
2	8.6.1.1	11	20
E	9.2.3.4	9	
3	8.4.1.1	13	6
Add.			
4	1.1.2.1	7	20
B	9.4.2.4	13	
5	1.1.6.3	10	13
I	9.11.1.6	3	
6	7.2.1.1	6	17
A	9.9.3.4	11	
7	1.2.4.4	13	18
F	9.4.4.2	5	
8	8.8.6.3	21	6
Add.	9.1.5.1	2	
	9.1.1.2	8	
	9.1.5.1	2	
9	7.2.2.1	6	19
D	9.1.3.4	8	
	9.4.3.2	5	
10	7.5.5.3	15	6
Add.	9.1.3.2	4	
	9.1.2.2	6	
11	1.1.3.1	7	20
C	9.9.2.2	13	
12	7.5.2.4	15	6
Add.	9.1.2.2	6	
13	7.4.3.1	14	14
H			
14	5.2.1.1	17	20
J	9.8.5.1	3	
<b>Total K = 202</b>			

D

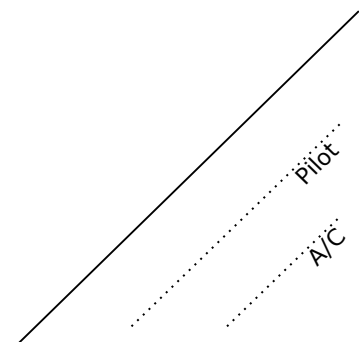



EIAC, Deva, Romania 2021		Form B
Pilot ID	CIVA Intermediate Unknown1	Flight #

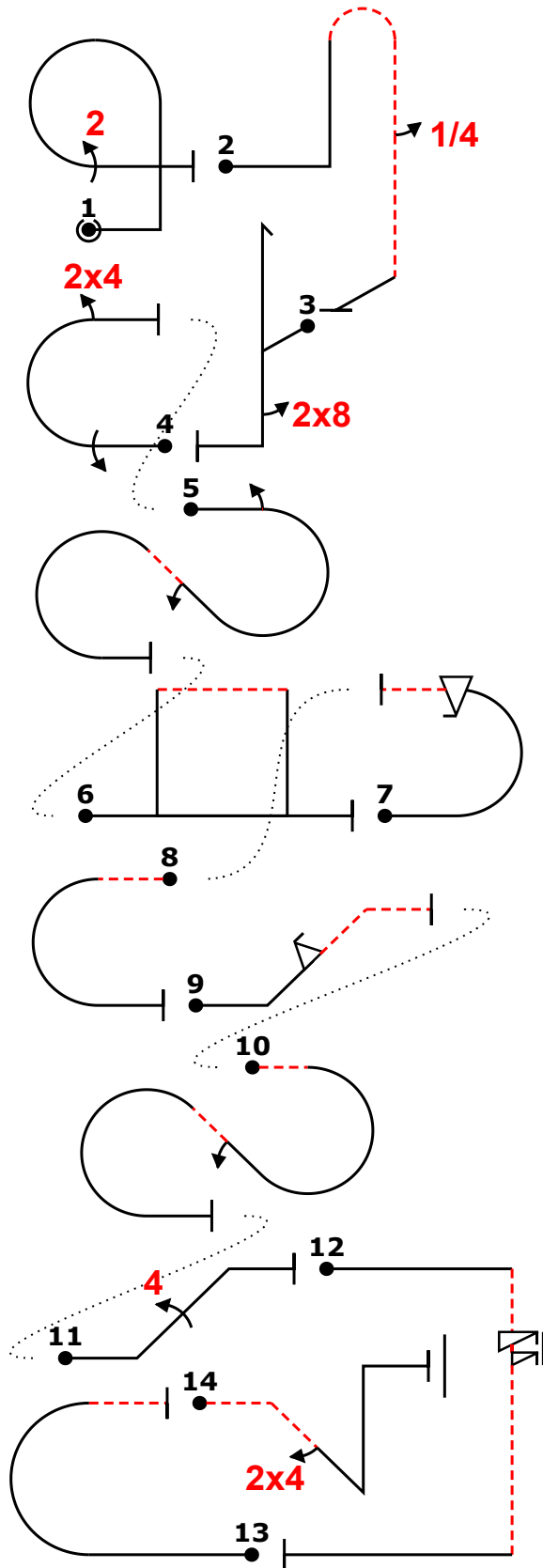
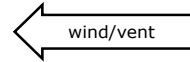

Power			
Fig	Aresti	K	
1	8.6.1.1	11	20
E	9.2.3.4	9	
2	8.4.3.1	15	17
G	9.1.5.1	2	
3	5.2.1.1	17	20
J	9.8.5.1	3	
4	7.2.2.1	6	19
D	9.1.3.4	8	
	9.4.3.2	5	
5	7.5.5.3	15	6
Add.	9.1.3.2	4	
	9.1.2.2	6	
6	7.4.3.1	14	14
H			
7	7.2.1.1	6	17
A	9.9.3.4	11	
8	7.2.1.4	6	6
Add.			
9	1.1.3.1	7	20
C	9.9.2.2	13	
10	7.5.2.4	15	6
Add.	9.1.2.2	6	
11	1.1.2.1	7	20
B	9.4.2.4	13	
12	1.1.6.3	10	13
I	9.11.1.6	3	
13	7.2.1.1	6	6
Add.			
14	1.2.4.4	13	18
F	9.4.4.2	5	
<b>Total K = 202</b>			

E

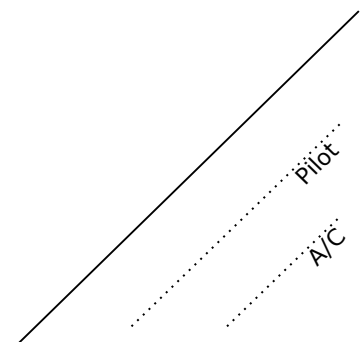



EIAC, Deva, Romania 2021		Form B
Pilot ID	CIVA Intermediate Unknown1	
		Flight #

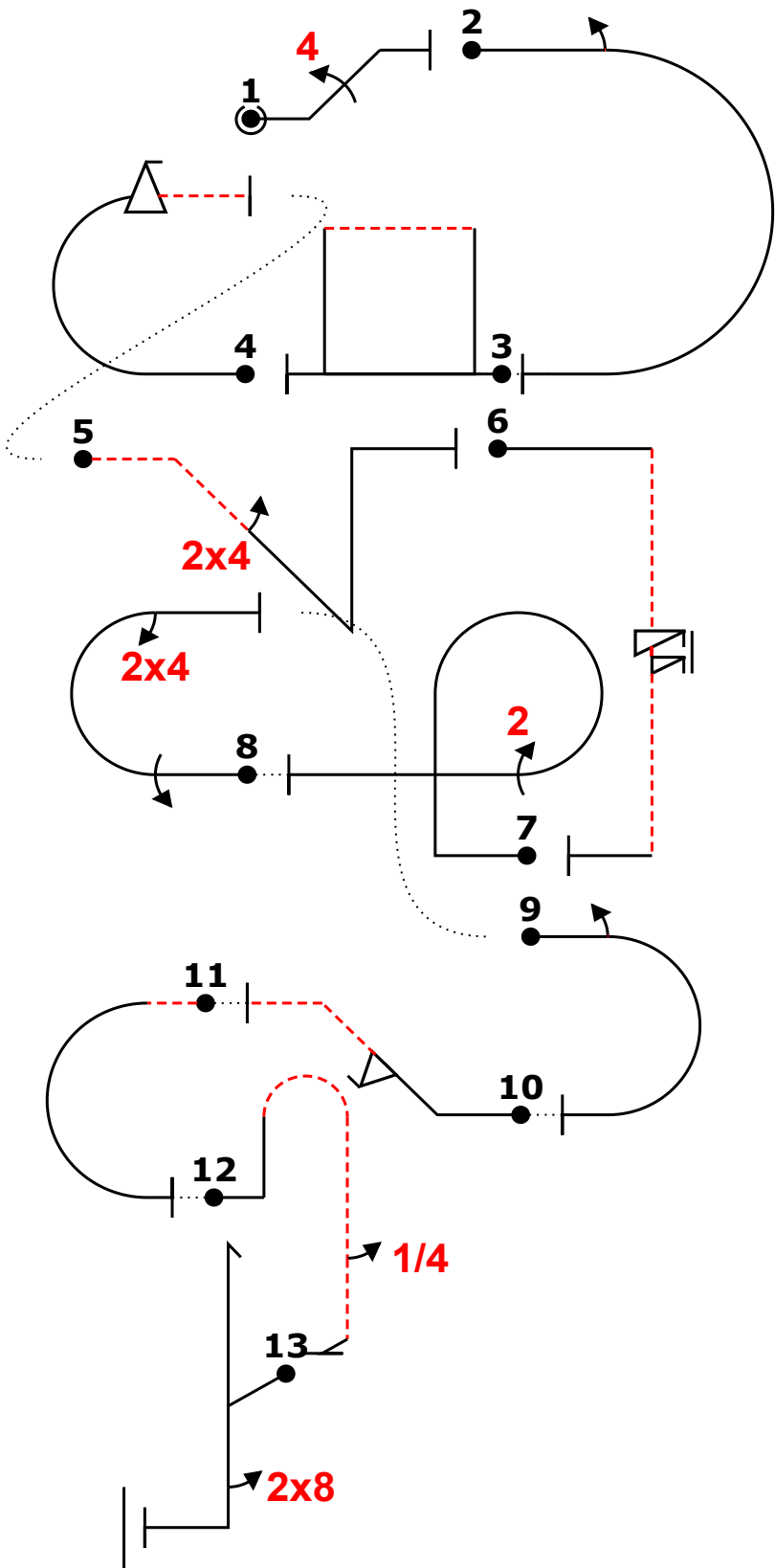
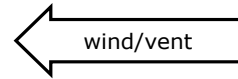

Power			
Fig	Aresti	K	
1	1.1.2.1	7	20
B	9.4.2.4	13	
2	7.2.3.3	6	8
Add.	9.1.3.2	4	
3	7.4.3.1	14	14
4	7.2.1.1	6	17
A	9.9.3.4	11	
5	1.2.4.4	13	18
F	9.4.4.2	5	
6	1.1.6.3	10	13
I	9.11.1.6	3	
7	8.6.1.1	11	20
E	9.2.3.4	9	
8	7.2.2.1	6	19
D	9.1.3.4	8	
	9.4.3.2	5	
9	7.2.3.3	6	8
Add.	9.1.3.2	4	
10	1.1.3.1	7	20
C	9.9.2.2	13	
11	7.2.1.4	6	8
Add.			
12	8.4.3.1	15	17
G	9.1.5.1	2	
13	5.2.1.1	17	20
J	9.8.5.1	3	
<b>Total K = 202</b>			

F

\_\_\_\_\_  
 ..... Pilot  
 ..... A/C



EIAC, Deva, Romania 2021		Form B
Pilot ID	CIVA Intermediate Unknown1	Flight #

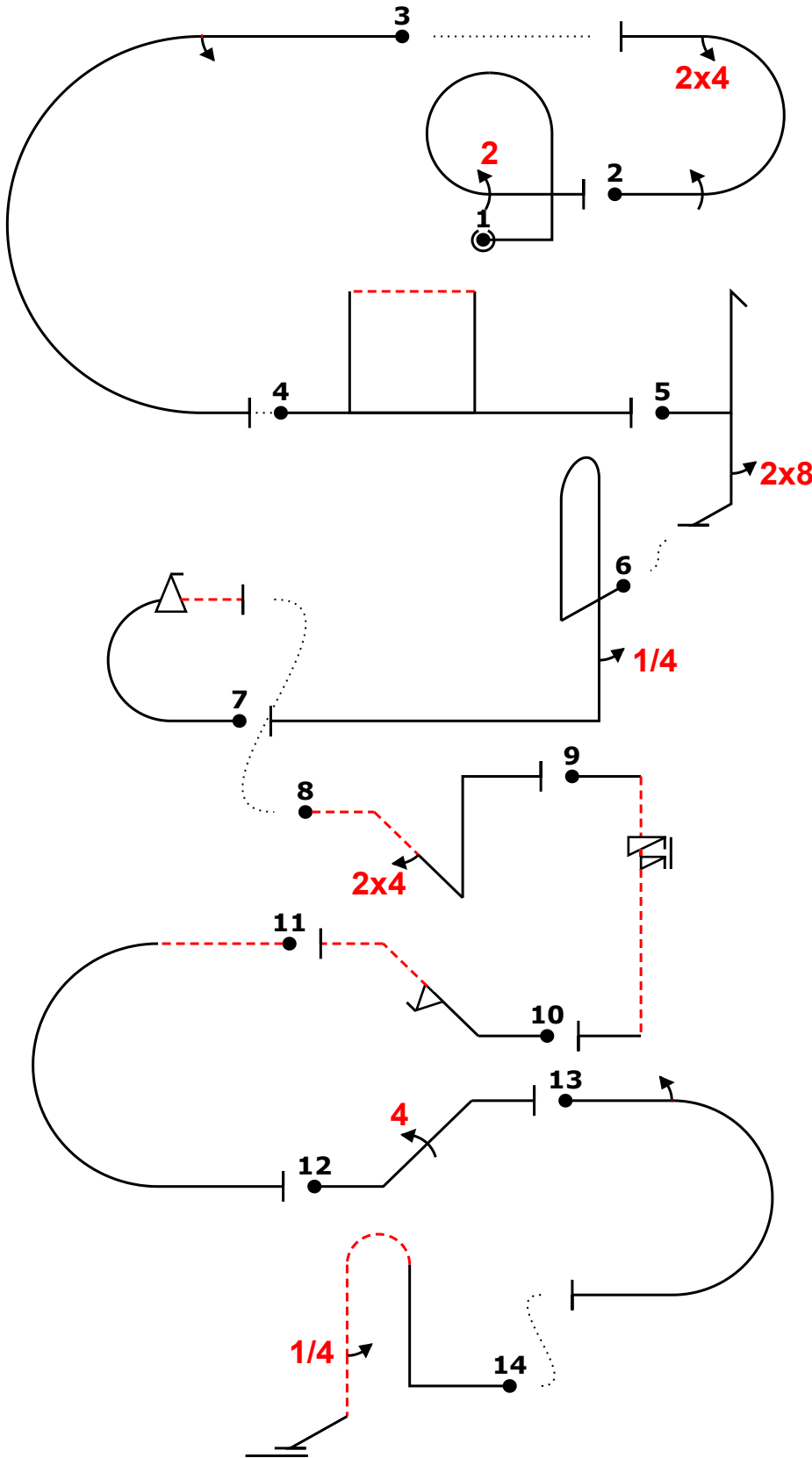
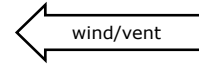

Power			
Fig	Aresti	K	
1	8.6.1.1	11	20
E	9.2.3.4	9	
2	7.2.2.1	6	19
D	9.1.3.4	8	
	9.4.3.2	5	
3	7.2.3.3	6	6
Add.	9.1.3.2	4	
4	7.4.3.1	14	14
5	5.2.1.1	17	20
J	9.8.5.1	3	
6	8.4.1.1	13	6
Add.	9.1.5.1	2	
7	7.2.1.1	6	17
A	9.9.3.4	11	
8	1.2.4.4	13	18
F	9.4.4.2	5	
9	1.1.6.3	10	13
I	9.11.1.6	3	
10	1.1.3.1	7	20
C	9.9.2.2	13	
11	7.2.1.4	6	6
12	1.1.2.1	7	20
B	9.4.2.4	13	
13	7.2.3.3	6	6
Add.	9.1.3.2	4	
14	8.4.3.1	15	17
G	9.1.5.1	2	
<b>Total K = 202</b>			

G

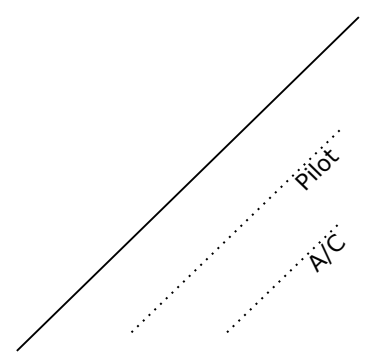



EIAC, Deva, Romania 2021		Form B
Pilot ID	CIVA Intermediate Unknown1	
		Flight #

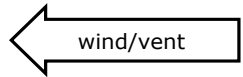

H

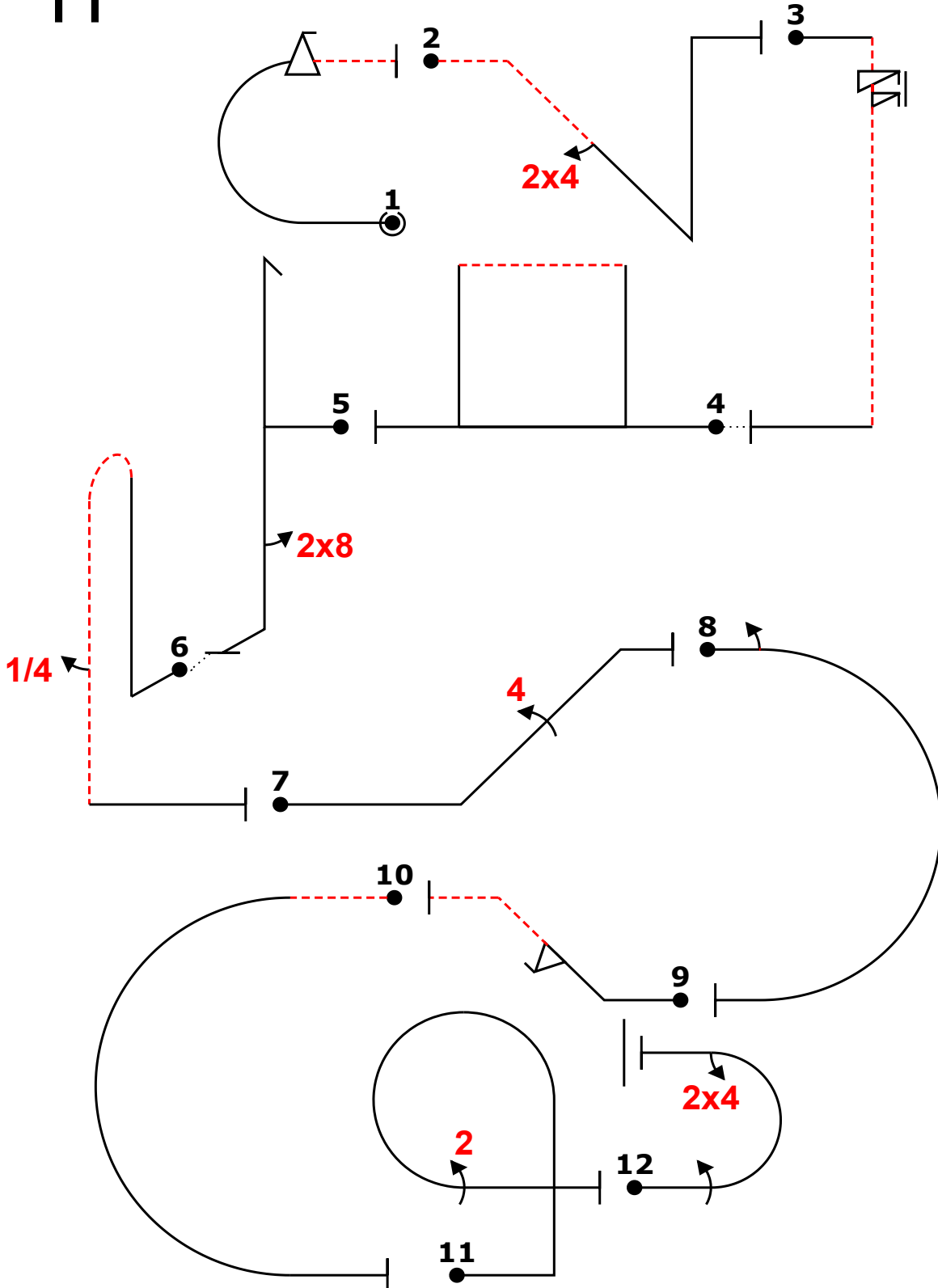

Power			
Fig	Aresti	K	
1	7.2.1.1	6	17
A	9.9.3.4	11	17
2	1.2.4.4	13	18
F	9.4.4.2	5	18
3	1.1.6.3	10	13
I	9.11.1.6	3	13
4	7.4.3.1	14	14
5	5.2.1.1	17	20
J	9.8.5.1	3	20
6	8.4.3.1	15	17
G	9.1.5.1	2	17
7	1.1.2.1	7	20
B	9.4.2.4	13	20
8	7.2.3.3	6	12
Add.	9.1.3.2	4	12
9	1.1.3.1	7	20
C	9.9.2.2	13	20
10	7.2.1.4	6	12
Add.			
11	8.6.1.1	11	20
E	9.2.3.4	9	20
12	7.2.2.1	6	19
D	9.1.3.4	8	19
	9.4.3.2	5	19
<b>Total K = 202</b>			

\_\_\_\_\_/ Pilot  
 ...../ A/C





EIAC, Deva, Romania 2021		Form B
Pilot ID	CIVA Intermediate Unknown1	Flight #

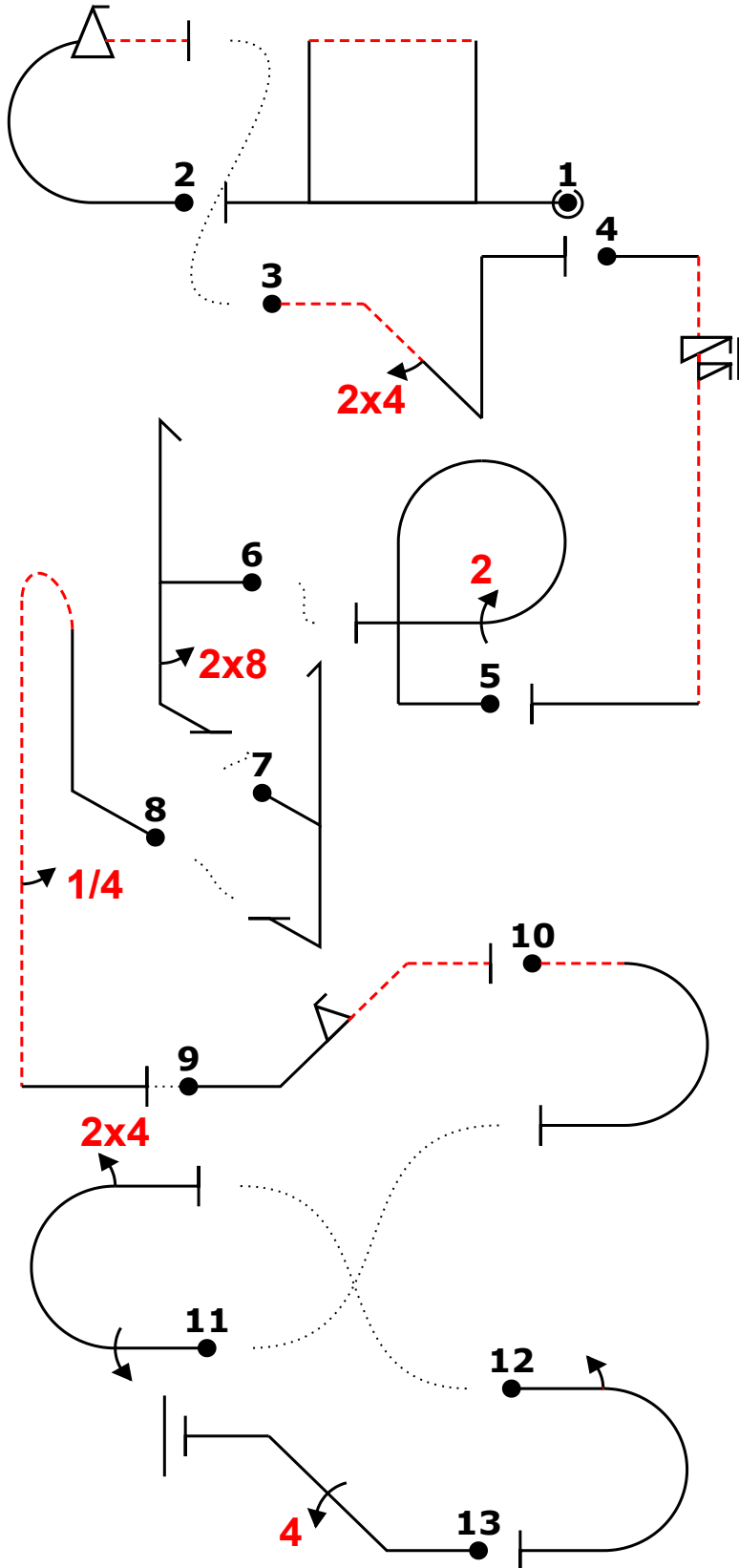
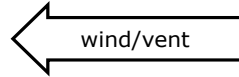

Power			
Fig	Aresti	K	
1 H	7.4.3.1	14	14
2 A	7.2.1.1 9.9.3.4	6 11	17
3 F	1.2.4.4 9.4.4.2	13 5	18
4 I	1.1.6.3 9.11.1.6	10 3	13
5 E	8.6.1.1 9.2.3.4	11 9	20
6 J	5.2.1.1 9.8.5.1	17 3	20
7 Add.	5.2.1.1	17	8
8 G	8.4.3.1 9.1.5.1	15 2	17
9 C	1.1.3.1 9.9.2.2	7 13	20
10 Add.	7.2.1.4	6	8
11 D	7.2.2.1 9.1.3.4 9.4.3.2	6 8 5	19
12 Add.	7.2.3.3 9.1.3.2	6 4	8
13 B	1.1.2.1 9.4.2.4	7 13	20
<b>Total K = 202</b>			

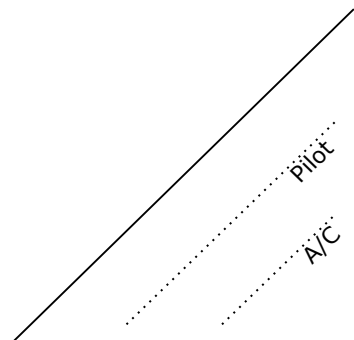



EIAC, Deva, Romania 2021		Form B
Pilot ID	CIVA Intermediate Unknown1	
		Flight #

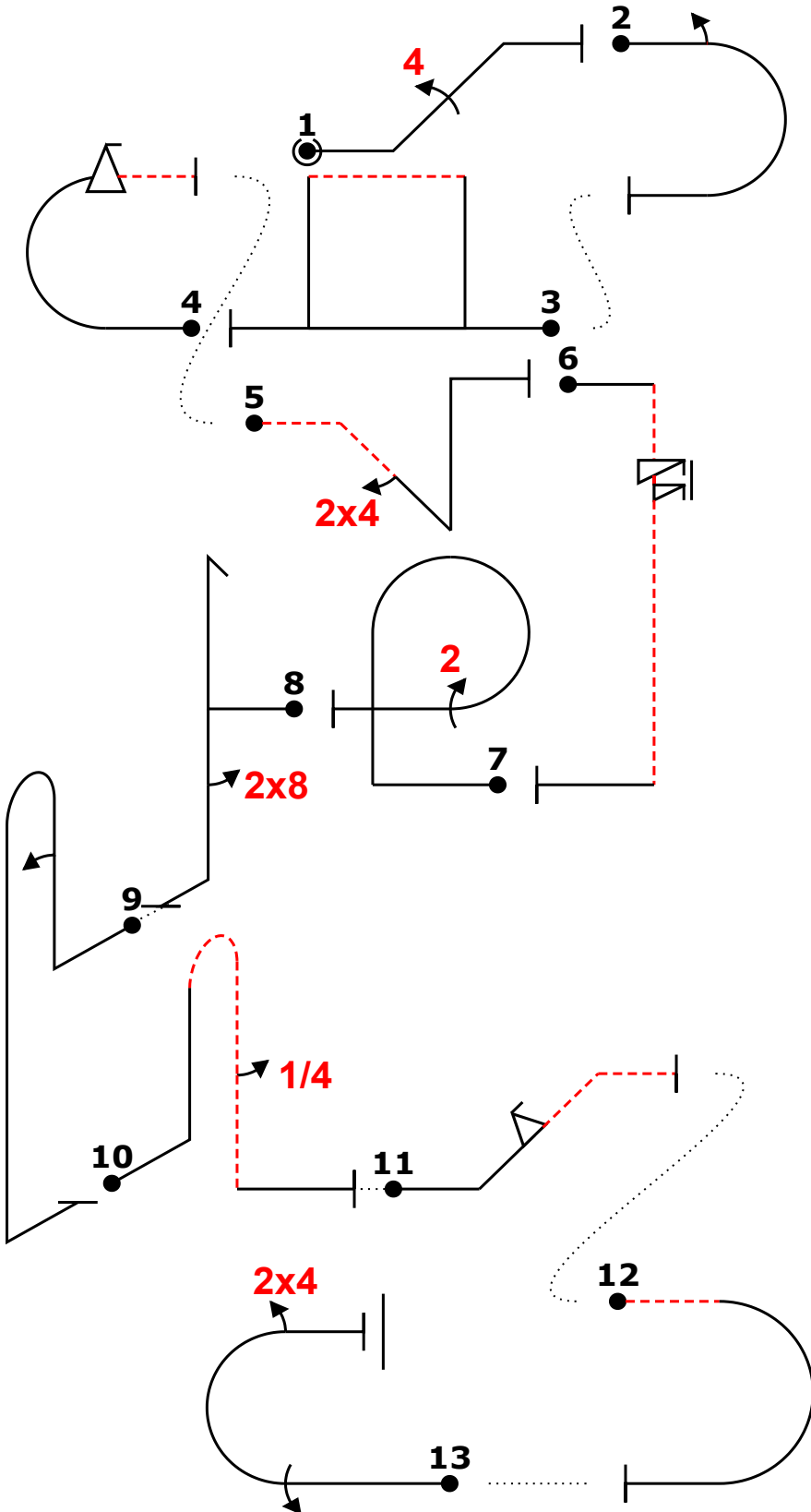
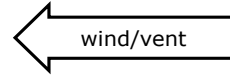

J

Power			
Fig	Aresti	K	
1	1.1.2.1	7	20
B	9.4.2.4	13	
2	7.2.3.3	6	8
Add.	9.1.3.2	4	
3	7.4.3.1	14	14
4	7.2.1.1	6	17
A	9.9.3.4	11	
5	1.2.4.4	13	18
F	9.4.4.2	5	
6	1.1.6.3	10	13
I	9.1.1.6	3	
7	8.6.1.1	11	20
E	9.2.3.4	9	
8	5.2.1.1	17	20
J	9.8.5.1	3	
9	8.4.1.1	13	8
Add.	9.1.1.2	8	
10	8.4.3.1	15	17
G	9.1.5.1	2	
11	1.1.3.1	7	20
C	9.9.2.2	13	
12	7.2.1.4	6	8
Add.			
13	7.2.2.1	6	19
D	9.1.3.4	8	
	9.4.3.2	5	
<b>Total K = 202</b>			

\_\_\_\_\_/ Pilot  
 ...../ A/C



		Form B
Pilot ID	CIVA Intermediate Programme2	Flight #

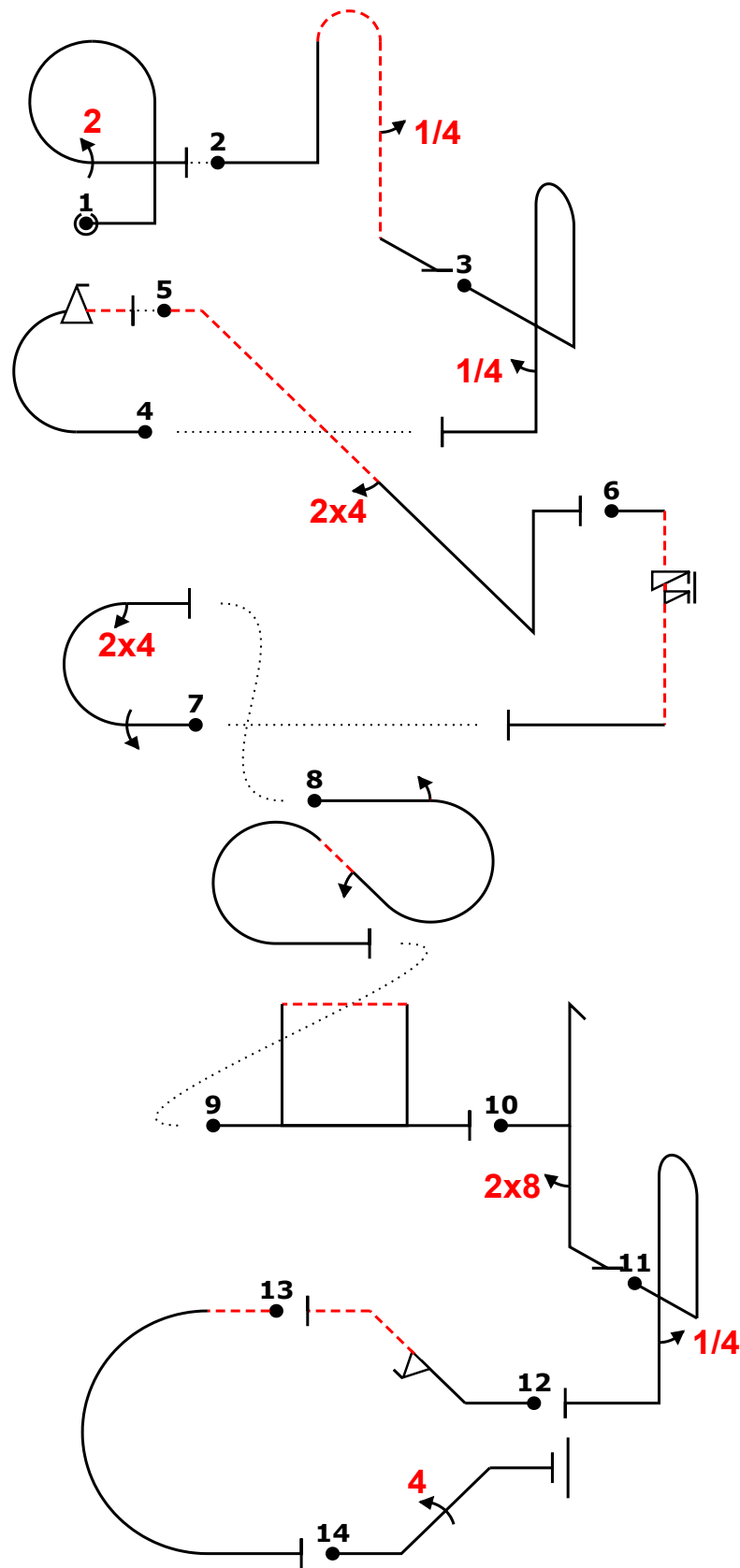
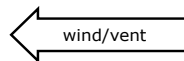

Power			
Fig	Aresti	K	
1	8.6.1.1 E 9.2.3.4	11 9	20
2	8.4.3.1 G 9.1.5.1	15 2	17
3	8.4.1.1 Add. 9.1.5.1	13 2	6
4	7.2.1.1 A 9.9.3.4	6 11	17
5	1.2.4.4 F 9.4.4.2	13 5	18
6	1.1.6.3 I 9.11.1.6	10 3	13
7	7.2.2.1 D 9.1.3.4 9.4.3.2	6 8 5	19
8	7.5.5.3 Add. 9.1.3.2 9.1.2.2	15 4 6	6
9	7.4.3.1 H	14	14
10	5.2.1.1 J 9.8.5.1	17 3	20
11	8.4.1.1 Add. 9.1.5.1	13 2	6
12	1.1.3.1 C 9.9.2.2	7 13	20
13	7.2.1.4 Add.	6	6
14	1.1.2.1 B 9.4.2.4	7 13	20
<b>Total K = 202</b>			

K

\_\_\_\_\_ Pilot  
 ..... A/C



EIAC, Deva, Romania 2021		Form B
Pilot ID	CIVA Intermediate Unknown1	
		Flight #

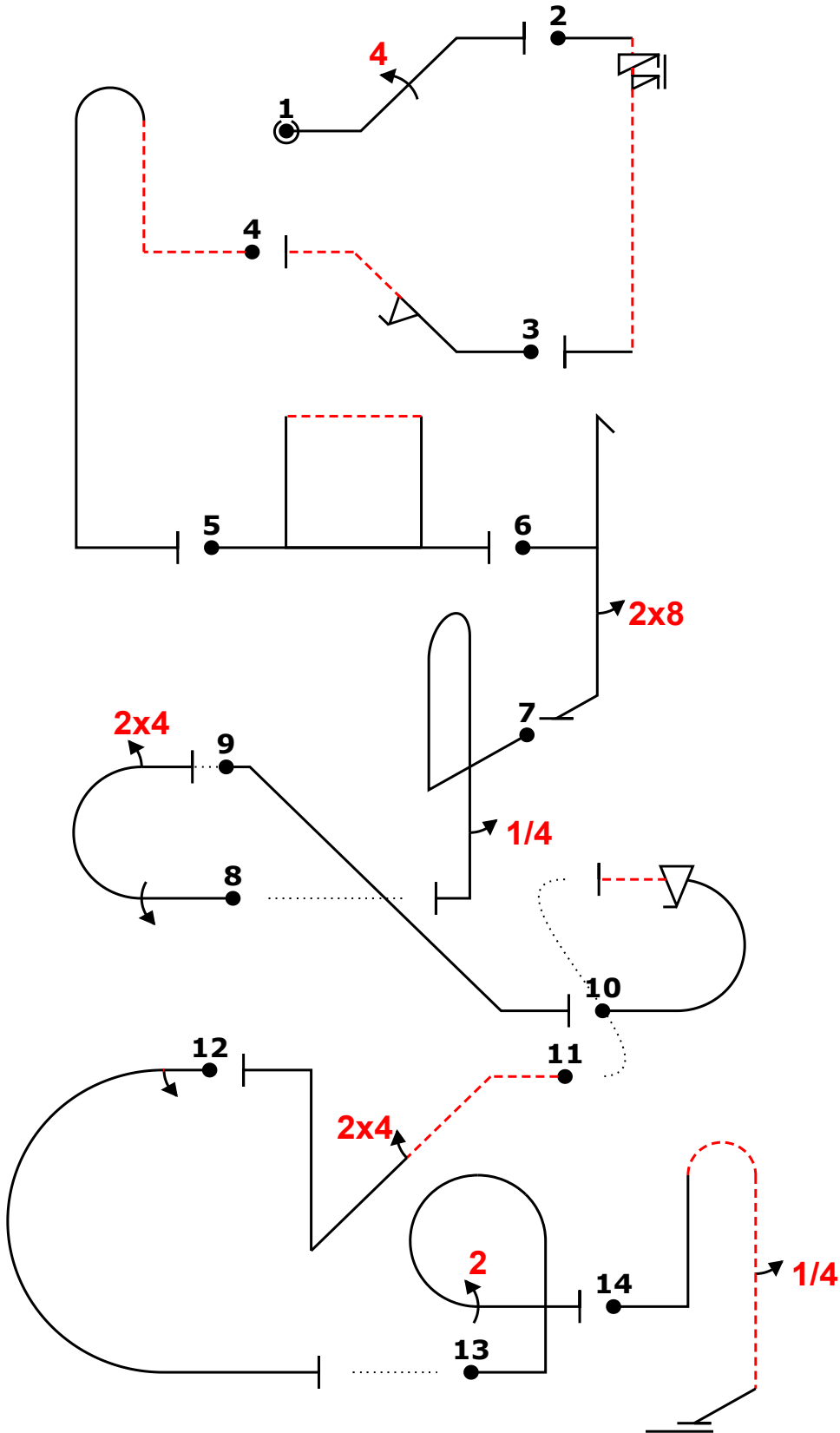
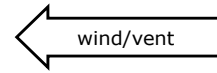

Power			
Fig	Aresti	K	
1	1.1.2.1	7	20
B	9.4.2.4	13	
2	1.1.6.3	10	13
I	9.11.1.6	3	
3	1.1.3.1	7	20
C	9.9.2.2	13	
4	8.4.4.2	14	6
<b>Add.</b>			
5	7.4.3.1	14	14
H			
6	5.2.1.1	17	20
J	9.8.5.1	3	
7	8.4.1.1	13	6
<b>Add.</b>	9.1.5.1	2	
8	7.2.2.1	6	19
D	9.1.3.4	8	
	9.4.3.2	5	
9	1.1.2.3	7	6
<b>Add.</b>			
10	7.2.1.1	6	17
A	9.9.3.4	11	
11	1.2.4.4	13	18
F	9.4.4.2	5	
12	7.2.3.3	6	6
<b>Add.</b>	9.1.3.2	4	
13	8.6.1.1	11	20
E	9.2.3.4	9	
14	8.4.3.1	15	17
G	9.1.5.1	2	
<b>Total K = 202</b>			

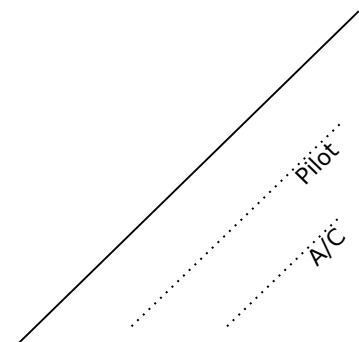



EIAC, Deva, Romania 2021		Form B
Pilot ID	CIVA Intermediate Unknown1	Flight #

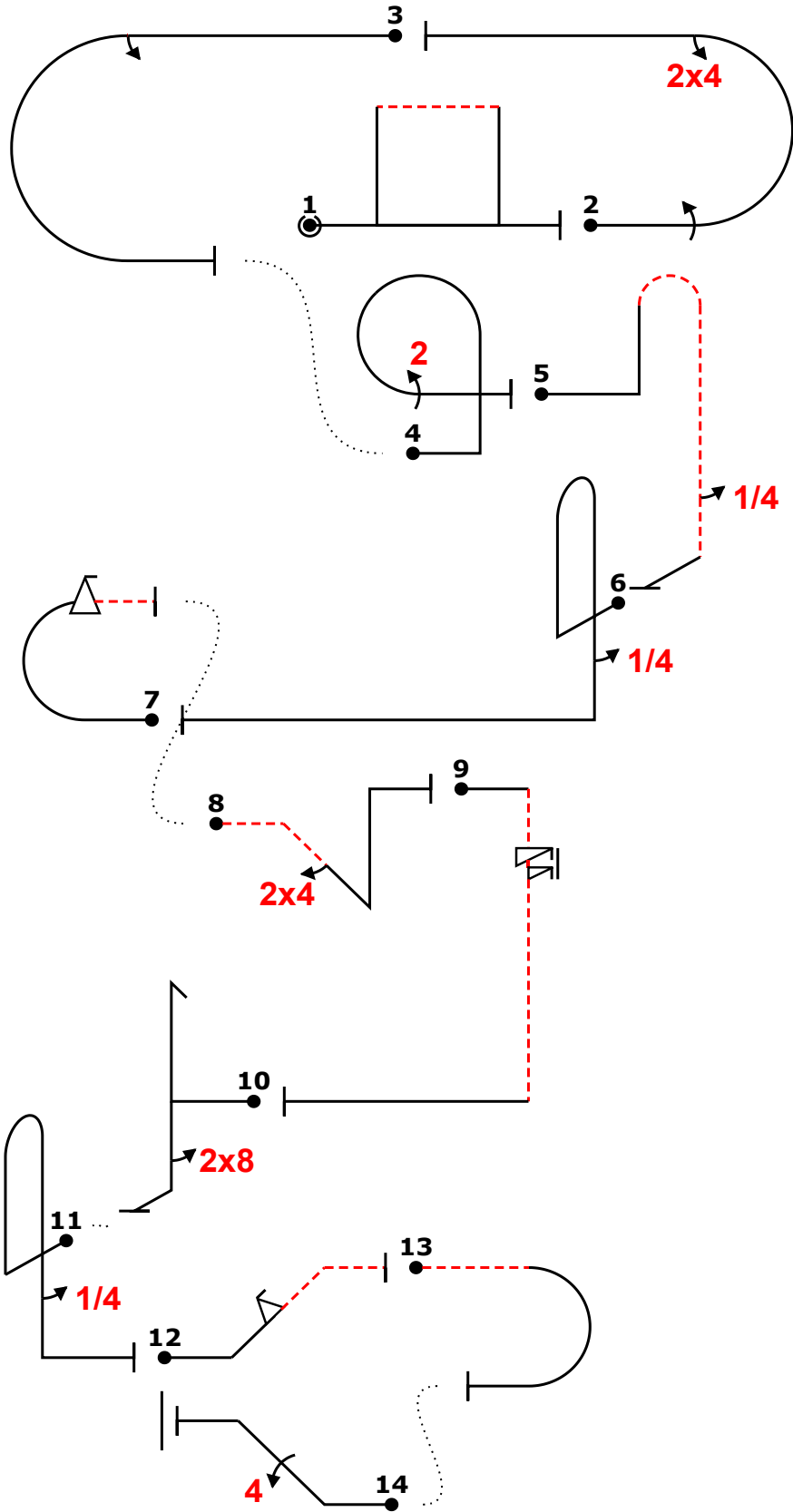
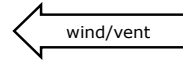

Power		
Fig	Aresti	K
1 H	7.4.3.1	14
2 D	7.2.2.1	6
	9.1.3.4	8
	9.4.3.2	5
3 Add.	7.2.3.3	6
	9.1.3.2	4
4	8.6.1.1	11
	9.2.3.4	9
5 G	8.4.3.1	15
	9.1.5.1	2
6 Add.	8.4.1.1	13
	9.1.5.1	2
7	7.2.1.1	6
	9.9.3.4	11
8	1.2.4.4	13
	9.4.4.2	5
9	1.1.6.3	10
	9.11.1.6	3
10	5.2.1.1	17
	9.8.5.1	3
11 Add.	8.4.1.1	13
	9.1.5.1	2
12 C	1.1.3.1	7
	9.9.2.2	13
13 Add.	7.2.1.4	6
		6
14 B	1.1.2.1	7
	9.4.2.4	13
<b>Total K = 202</b>		

M

